

CONSEJO TECNICO NACIONAL DE RECONSTRUCCION	
<b>DISEÑADORES</b>	
NOMBRE	FRMA
ARQUITECTA	KARLA MADROR MORA
ESTRUCTURA	LAURA MADROR MORA
ALUMINUMOS	ALDO WALTER FERREROTRANA
<b>ELECTRICIDAD</b>	
UJESSES MARTINEZ R.	
HEROSANTONIO	
ORLANDO BERNARDEZ	
INGENIERO	CARMEN D. MARTINEZ
DEBULO	
YAKOSKA Y. MEZA	
COORDINADOR	
LUIS JAVIER MEZA	
<b>REVISIONES</b>	
NOMBRE	FRMA
FECHA	

ESPECULADO:	
<b>ELECTRICIDAD</b>	
CONTENIDO:	

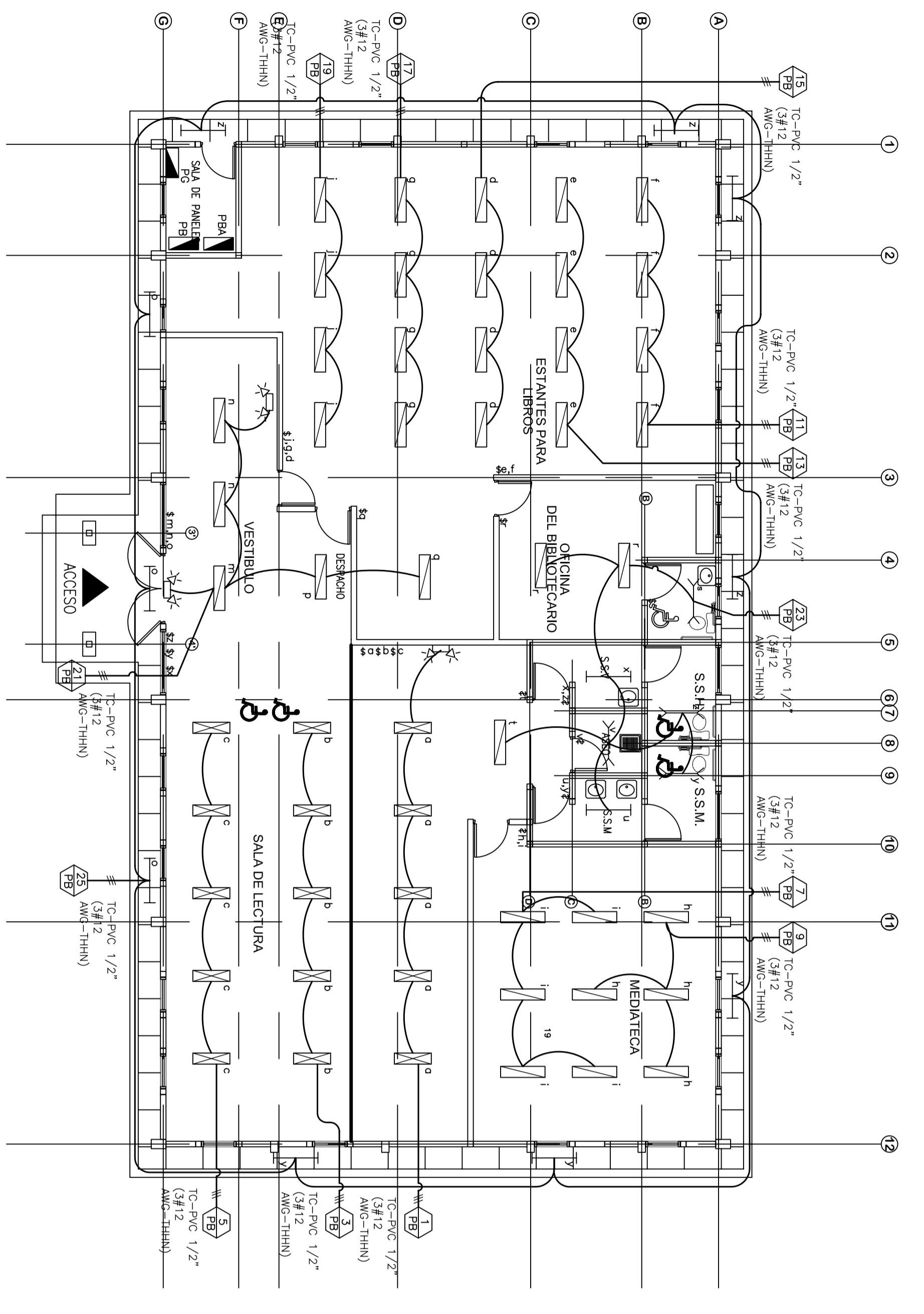

PLANTA DE ILUMINACION. EDIFICIO 8 (BIBLIOTECA)  
ESCALA 1 : 100

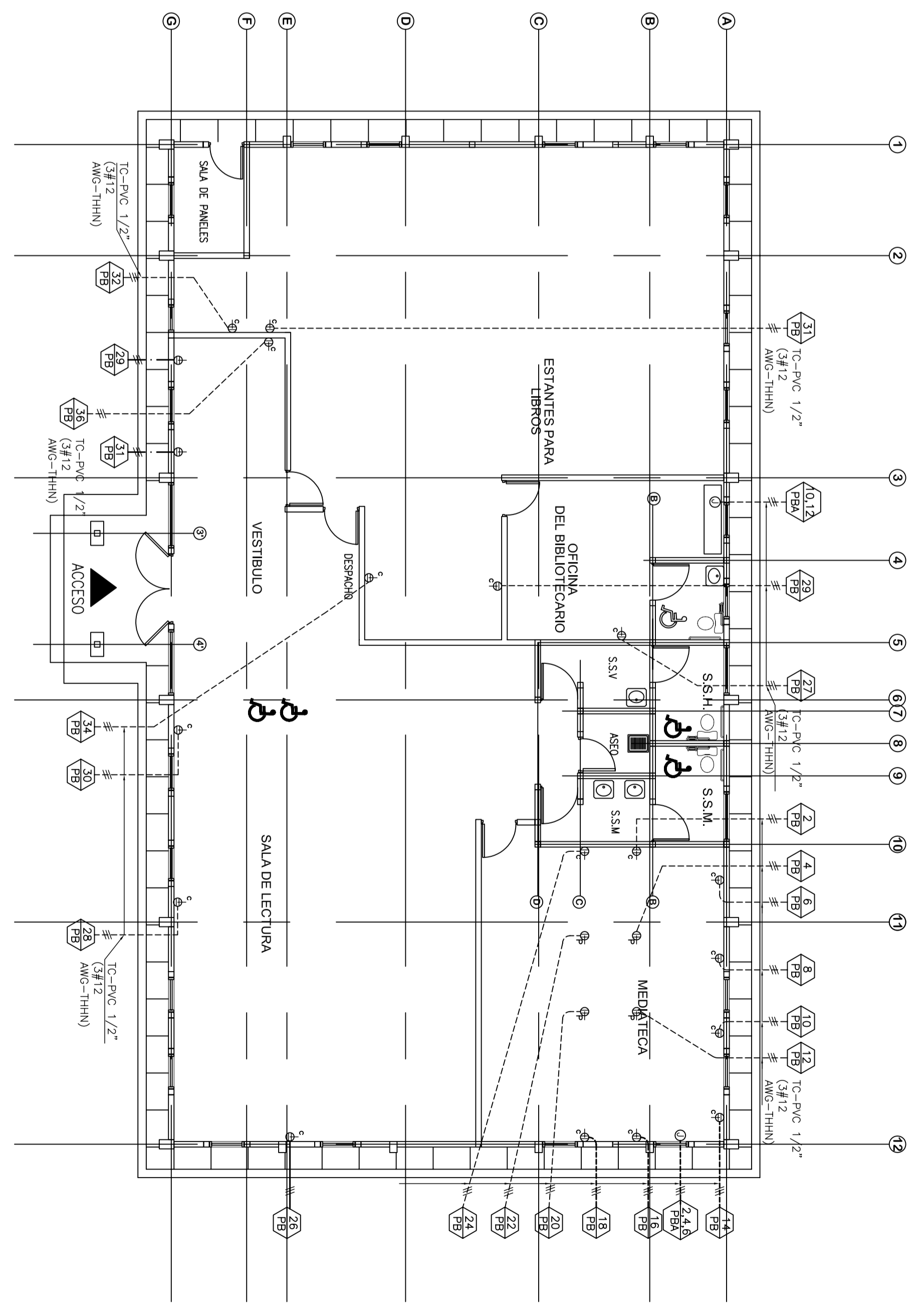

PLANTA DE TOMAS. EDIFICIO 8 (BIBLIOTECA)  
ESCALA 1 : 100

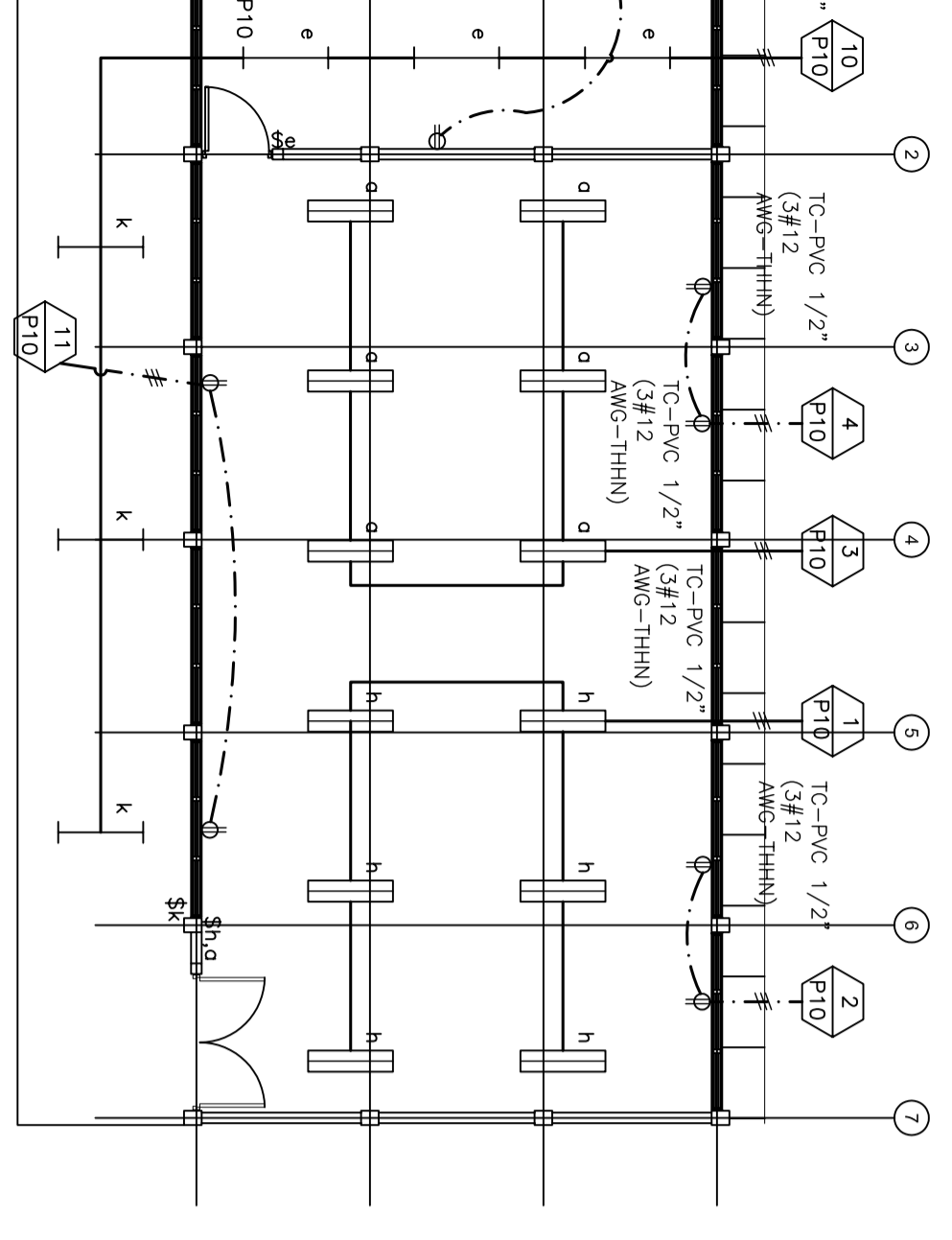



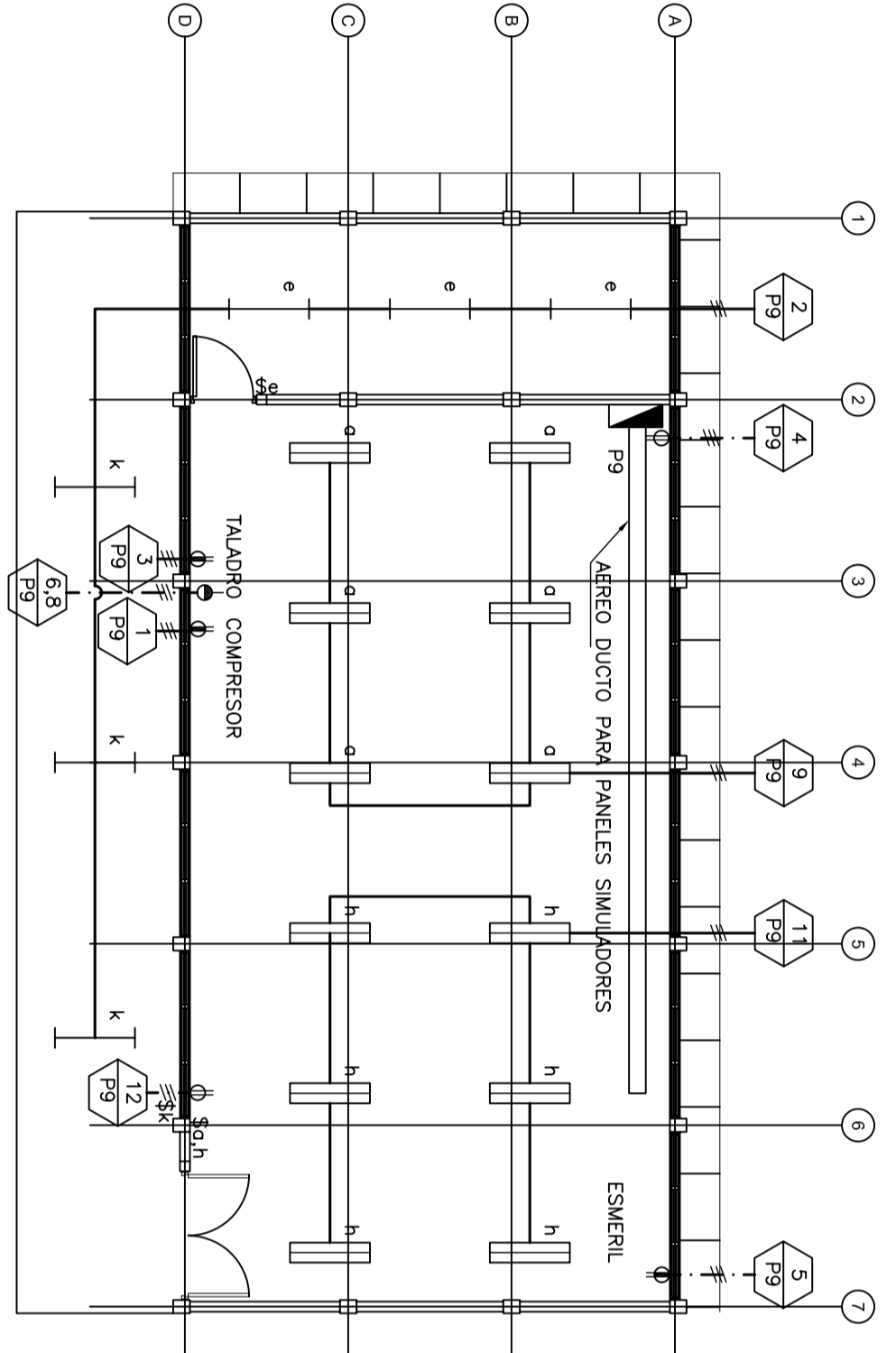



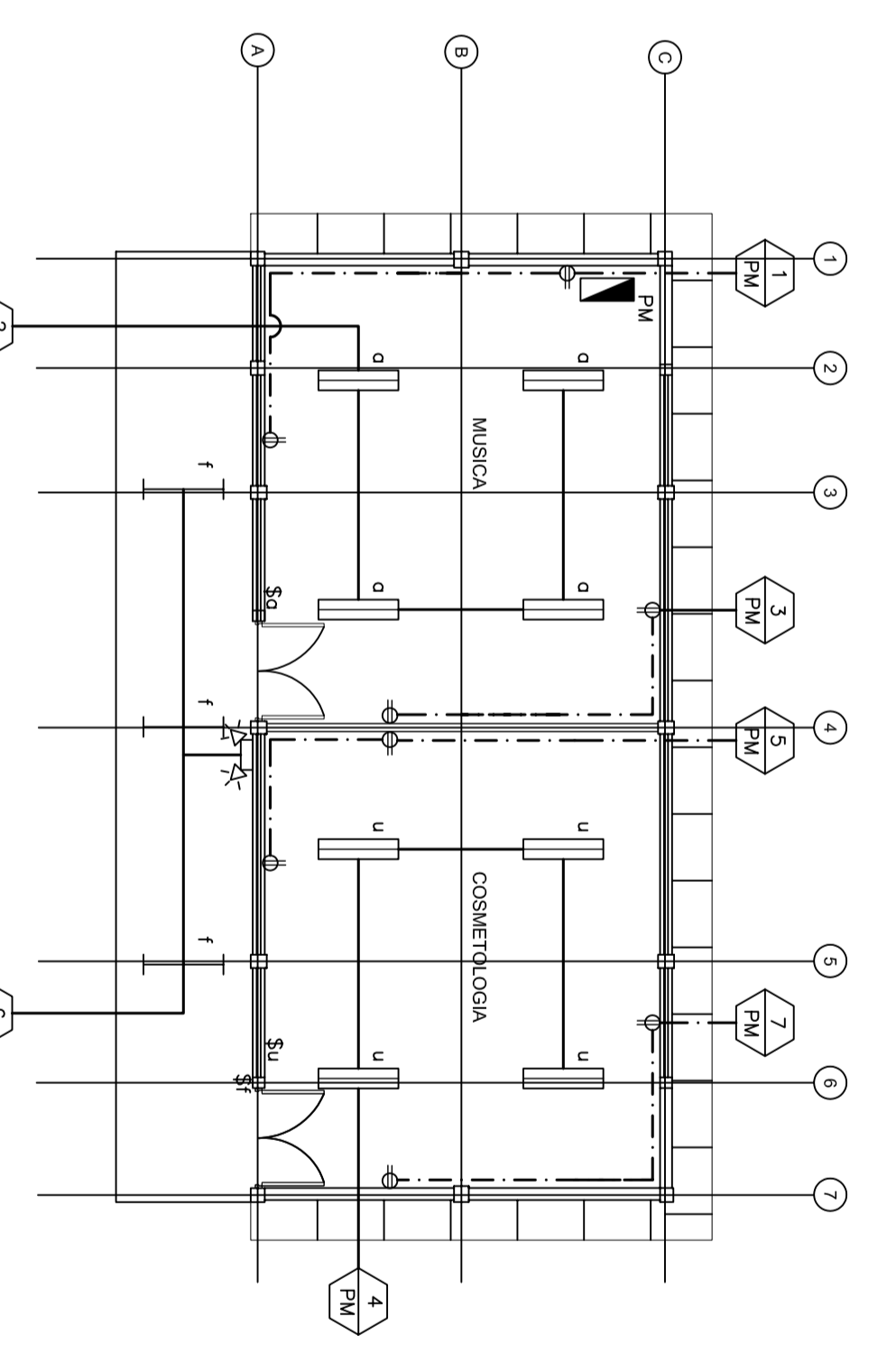



















ILUMINACION Y TOMAS. EDIFICIO 9  
ESCALA 1 : 100



ILUMINACION Y TOMAS. EDIFICIO 6  
ESCALA 1 : 100



	<b>SIMBOLOGIA ELECTRICA</b>
	PANEL ELECTRICO IMPULSIONAL CON BARRA DE TRABAJO Y MEDIDA N.110
	SWITCH
	VALVULO DE CORTADO Y PANEL N. 002 PREFERENCIA
	VALVULO DE CORTADO Y PANEL N. 002 PREFERENCIA
	VALVULO DE CORTADO Y PANEL N. 002 PREFERENCIA
	VALVULO DE CORTADO Y PANEL N. 002 PREFERENCIA
	VALVULO DE CORTADO Y PANEL N. 002 PREFERENCIA
	VALVULO DE CORTADO Y PANEL N. 002 PREFERENCIA
	VALVULO DE CORTADO Y PANEL N. 002 PREFERENCIA
	VALVULO DE CORTADO Y PANEL N. 002 PREFERENCIA
	VALVULO DE CORTADO Y PANEL N. 002 PREFERENCIA
	VALVULO DE CORTADO Y PANEL N. 002 PREFERENCIA
	VALVULO DE CORTADO Y PANEL N. 002 PREFERENCIA
	VALVULO DE CORTADO Y PANEL N. 002 PREFERENCIA
	VALVULO DE CORTADO Y PANEL N. 002 PREFERENCIA
	VALVULO DE CORTADO Y PANEL N. 002 PREFERENCIA
	VALVULO DE CORTADO Y PANEL N. 002 PREFERENCIA
	VALVULO DE CORTADO Y PANEL N. 002 PREFERENCIA
	VALVULO DE CORTADO Y PANEL N. 002 PREFERENCIA
	VALVULO DE CORTADO Y PANEL N. 002 PREFERENCIA
	VALVULO DE CORTADO Y PANEL N. 002 PREFERENCIA
	VALVULO DE CORTADO Y PANEL N. 002 PREFERENCIA
	VALVULO DE CORTADO Y PANEL N. 002 PREFERENCIA
	VALVULO DE CORTADO Y PANEL N. 002 PREFERENCIA
	VALVULO DE CORTADO Y PANEL N. 002 PREFERENCIA

PLANTA DE ILUMINACION Y TOMAS EDIFICIOS 6, 8, 9 Y 10  
ESCALA 1 : 100

ESCALA:	INDICADA
LAMINA:	RE:
<b>IE-07</b>	<b>IE-13</b>
CONSEJUTIVO:	100 de 112
<b>ABRIL 2011</b>	